



Description

Rio

Its practical opening mechanism makes Rio an excellent solution in terms of ease of use. Ideal for both commercial use (hotels, restaurants...) and residential use (villas, private gardens). Aluminium framework, rotating 360° around its base, and easy pulley opening mechanism. Stainless steel hardware. The ribs can be replaced individually without needing to disassemble the entire structure and the canopy fabric is easily removed for maintenance or replacement. Rio can be supplied with a freestanding base or in-ground mount. All FIM products are designed and made in Italy, using the best materials for outdoor use, in order to guarantee exceptional durability even under the most demanding environmental conditions.

Drawings

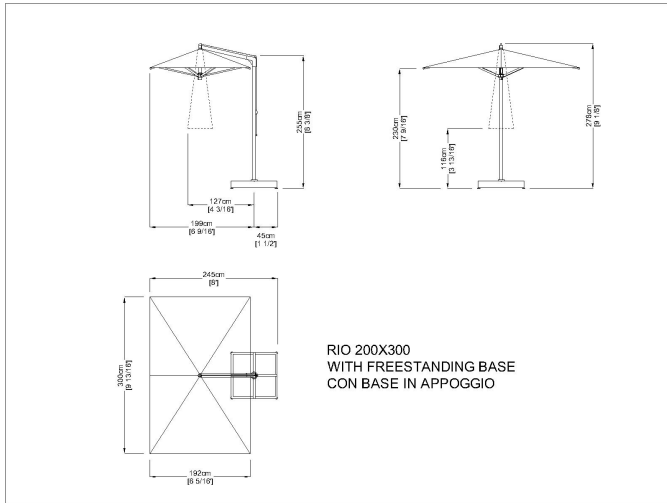

200 x 300

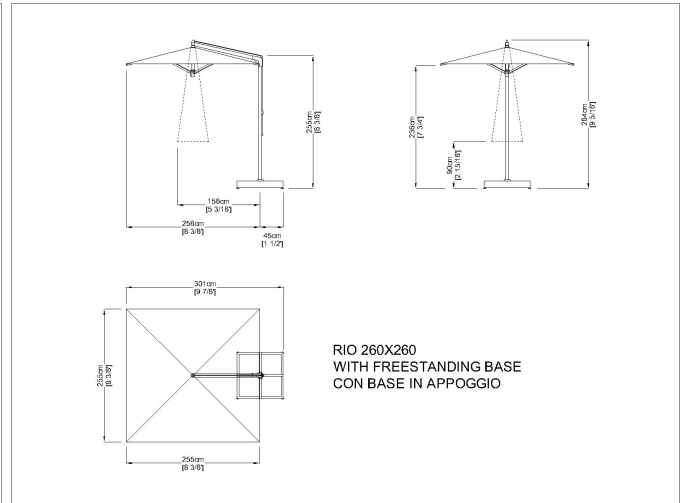

260 x 260

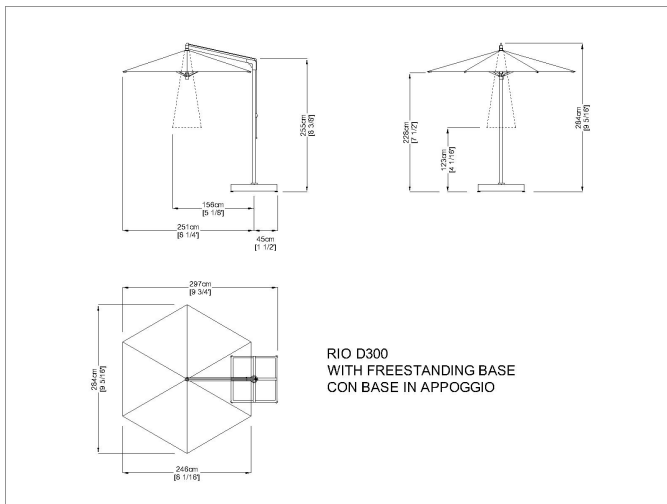

300

Materials

Solution dyed Acrylic Fabric

Designed for outdoor use, the solution (spun) dyed acrylic fabric resists salt water, chlorine and any type of harsh climate. Colours do not bleed and remain vibrant for a long time. A specific treatment makes the fabric water repellent, mould resistant and protects it from staining. This type of fabric resists the most extreme conditions and is suitable for year-round use in gardens, terraces, pool sides or on-board boats. It's definitely the top choice canopy fabric to select for your Product. UPF 50+ (UV Protection Factor) 280 gr/m2.



N01 Sooty
10030



S00 Natural
5404



S01 Canvas
5423

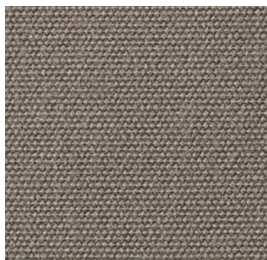

S04 Taupe
3729

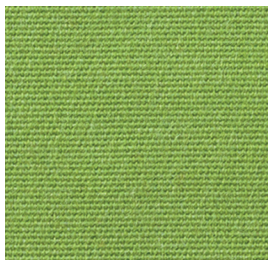

S06 Macao
3738

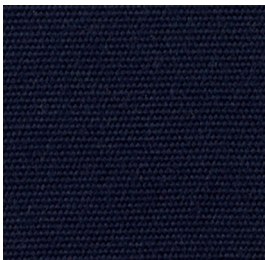

S09 Navy Blue
5439



S13 Black
5408



S16 Shingles
3706



S30 Blue Storm
3942



S33 Mimosa
3938

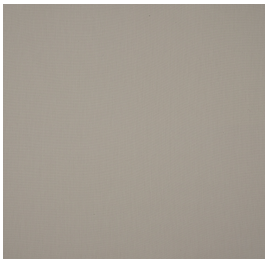

S35 Stone
3988

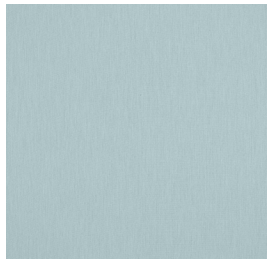

S37 Curacao
3964

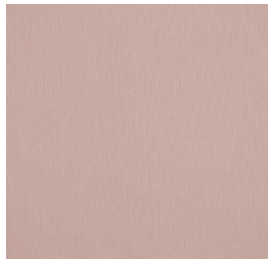

S38 Blush
3965

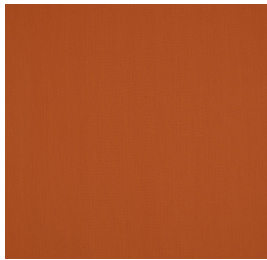

S39 Pumpkin
3969

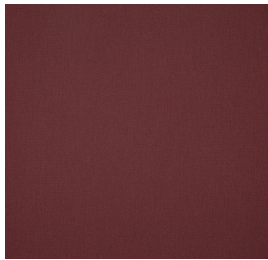

S40 Autumn
3882

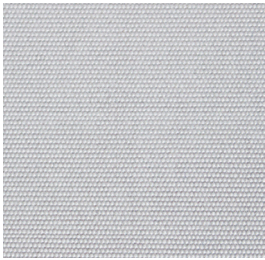

Z02 Silver grey
3741

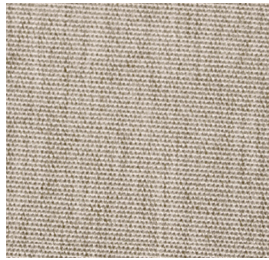

Z03 Lin
3780

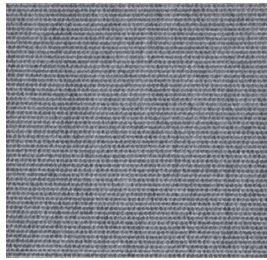

Z09 Lead Chiné
3756

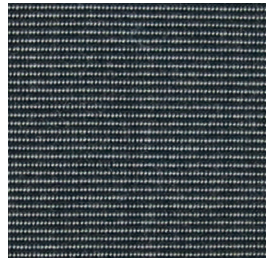

Z14 Charcoal
3705



Z15 Carbon
3906



Z18 Flanelle
3757

Solution dyed Acrylic Fabric - Special colours

Designed for outdoor use, the solution (spun) dyed acrylic fabric resists salt water, chlorine and any type of harsh climate. Colours do not bleed and remain vibrant for a long time. A specific treatment makes the fabric water repellent, mould resistant and protects it from staining. This type of fabric resists the most extreme conditions and is suitable for year-round use in gardens, terraces, pool sides or on-board boats. It's definitely the top choice canopy fabric to select for your Product. UPF 50+ (UV Protection Factor) 280 gr/m².

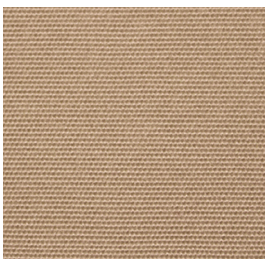

Z04 Antique Beige
5422

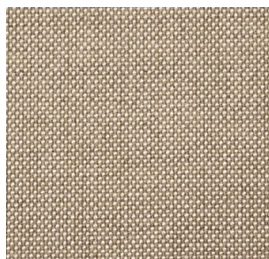

Z05 Arbor Pebble
48009

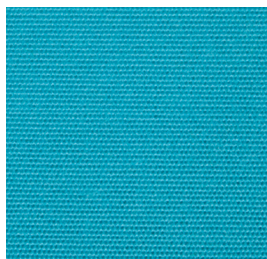

Z06 Aruba
5416

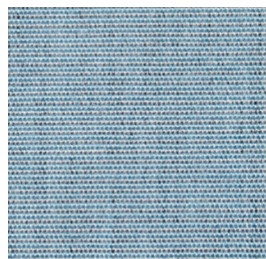

Z08 Mineral Blue Chiné
3793

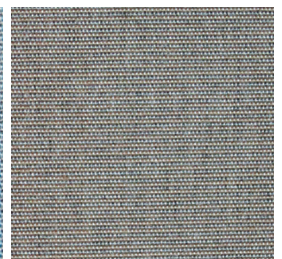

Z10 Taupe Chiné
3907

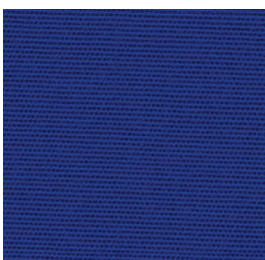

Z11 True Blue
5499

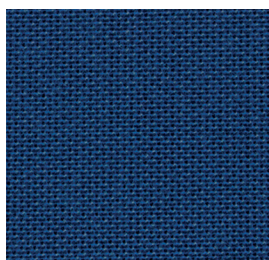

Z12 Riviera Blue
3717

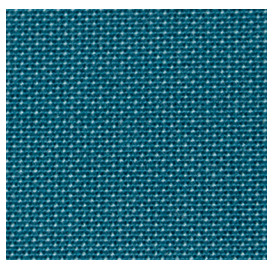

Z13 Adriatic
3941

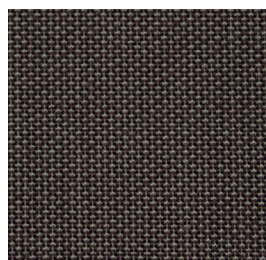

Z17 Mink Brown
3127



Z19 Dark Smoke
3729



Product Sheet

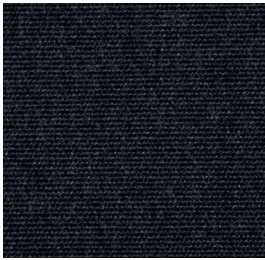

Z20 Sooty
3758

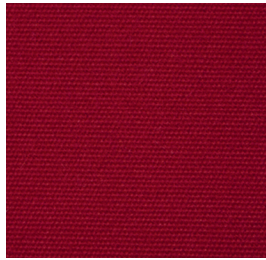

Z23 Paris Red
3728

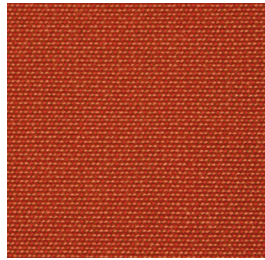

Z30 Paprika
3939

Olefim Fabric

Polypropylene solution (spun) dyed fabric, which guarantees stability and long-lasting colours. 100% recyclable, water repellent and stain-resistant. UPF 80 (UV Protection Factor) 190 gr/m².



F00 Melange
4202



F01 Cream
2736

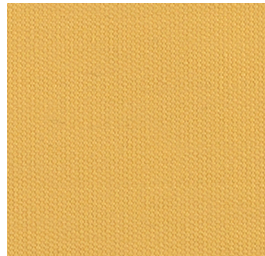

F02 Gold
2062

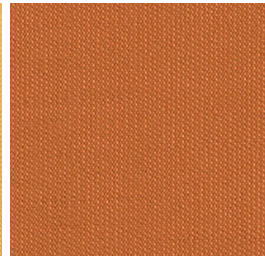

F03 Orange
2735

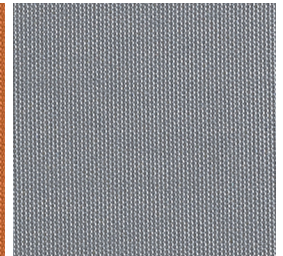

F04 Silver
2631

Finishes

The materials used have been specifically selected and treated to maintain our products durability and consistency over time. The lumber we source is the best available to guarantee structural integrity and strength of the product. The aluminum profiles are powder coated or anodized to ensure a longer durability in time. The colors may differ from the real ones.

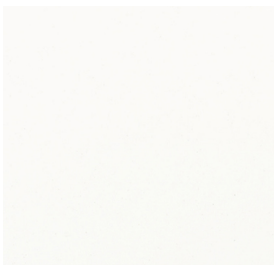

BIAN



GRAF



Product Sheet

Images



Suggested Products



Rodi



Ischia



Capri